



**FEATURES**

- Field-Bus remote data acquisition
- Modbus Slave device on RS232
- Modbus RTU/ Modbus ASCII protocol
- 8 channels input up to  $\pm 10$  V
- Watch-Dog Alarm
- Remotely Configurable
- 2000 Vac 3-ways Galvanic Isolation
- High Accuracy
- UL / CE mark
- DIN rail mounting in compliance with EN-50022



**GENERAL DESCRIPTION**

The device DAT 3017-V is able to acquire up to 8 analogue input signals. The data are transmitted with MODBUS RTU/MODBUS ASCII protocol on the RS-232 network (RS-485 interface is available).

It is possible to connect on input voltage signals up to  $\pm 10$  V.

The device guarantees high accuracy and stable measure versus time and temperature.

To ensure the plant safety, two Watch-Dog timer alarms are provided.

The isolation between the parts of circuit removes eventual ground-loop effects, allowing the use of the device even in the heavy environmental conditions.

The DAT 3017-V is in compliance with the Directive UL 61010-1 for US market and with the Directive CSA C22.2 No 61010-1 for the Canadian market.

The device is housed in a rough self-extinguishing plastic container which, thanks to its thin profile of 17.5mm only, allows a high density mounting on EN-50022 standard DIN rail.

**COMMUNICATION PROTOCOLS**

The DAT 3017-V is designed to work with the MODBUS RTU/MODBUS ASCII protocol: standard protocol in field-bus; allows to directly interface DAT3000 series devices to the larger part of PLCs and SCADA applications available on the market.

For the protocol instructions, refer to the User Guide of the device.

**USER INSTRUCTIONS**

Before to install the device, please read the "Installation Instruction" section.

If the module configuration is unknown, with device powered off, connect the INIT terminal to the GND terminal (ground), at the next power on the device will be auto-configured in the default settings (refer to the User Guide of the device).

Connect power supply, serial bus and analogue inputs as shown in the "Wiring" section.

The "PWR" LED state depends on the working condition of the device: see the "Light Signalling" section to verify the device working state.

To perform configuration and calibration operations, read the instructions in the User Guide of the device.

To simplify handling or replacing of the device, it is possible to remove the wired terminals even with the device powered.

**TECHNICAL SPECIFICATIONS (Typical @ 25 °C and in the nominal conditions)**

INPUT			Input Accuracy (1) Voltage	±10 mV	POWER SUPPLY Power supply voltage	10 .. 30 Vdc
Input type	Min	Max				
Voltage			Linearity (1) Voltage	± 0.1 % f.s.	Reverse polarity protection	60 Vdc max
10 V	-10 V	+10 V			Current consumption	30 mA max.
			Input Impedance Voltage	≥ 1 MΩ	<b>ISOLATION</b> Input – RS485 2000 Vac 50 Hz, 1 min. Supply – Input 2000 Vac 50 Hz, 1 min. Supply – RS485 2000 Vac 50 Hz, 1 min.	
			Thermal drift (1) Full scale	± 0.005 % / °C	<b>ENVIRONMENTAL CONDITIONS</b> Operative Temperature -10°C .. +60°C UL Operative Temperature -10°C .. +40°C Storage Temperature -40°C .. +85°C Humidity (not condensed) 0 .. 90 % Maximum Altitude 2000 m Installation Indoor Category of installation II Pollution Degree 2	
			Sample time	0.5 ÷ 1 sec.	<b>MECHANICAL SPECIFICATIONS</b> Material Self-extinguish plastic IP Code IP20 Wiring wires with diameter 0.8÷2.1 mm <sup>2</sup> /AWG 14-18 Tightening Torque 0.5 N m Mounting in compliance with DIN rail standard EN-50022 Weight about 150 g.	
			Data Transmission Baud Rate	38.4 Kbps	<b>CERTIFICATIONS</b> <b>EMC ( for industrial environments)</b> Immunity EN 61000-6-2 Emission EN 61000-6-4	
			Max. distance	1.2 Km – 4000 ft	<b>UL</b> US Standard UL 61010-1 Canadian Standard CSA C22.2 No 61010-1 CCN NRAQ/NRAQ7 Typology Open Type device Classification Industrial Control Equipment File Number E352854	

(1) Referred to input Span (difference between max. and min. values)

## INSTALLATION INSTRUCTIONS

The DAT 3017-V is suitable for fitting to DIN rails in the vertical position. For optimum operation and long life follow these instructions:

**When the devices are installed side by side it may be necessary to separate them by at least 5 mm in the following case:**

- If panel temperature exceeds 45°C and at least one of the overload conditions exist.

Make sure that sufficient air flow is provided for the device avoiding to place raceways or other objects which could obstruct the ventilation slits. Moreover it is suggested to avoid that devices are mounted above appliances generating heat; their ideal place should be in the lower part of the panel. Install the device in a place without vibrations.

Moreover it is suggested to avoid routing conductors near power signal cables (motors, induction ovens, inverters etc...) and to use shielded cable for connecting signals.

## CABLING

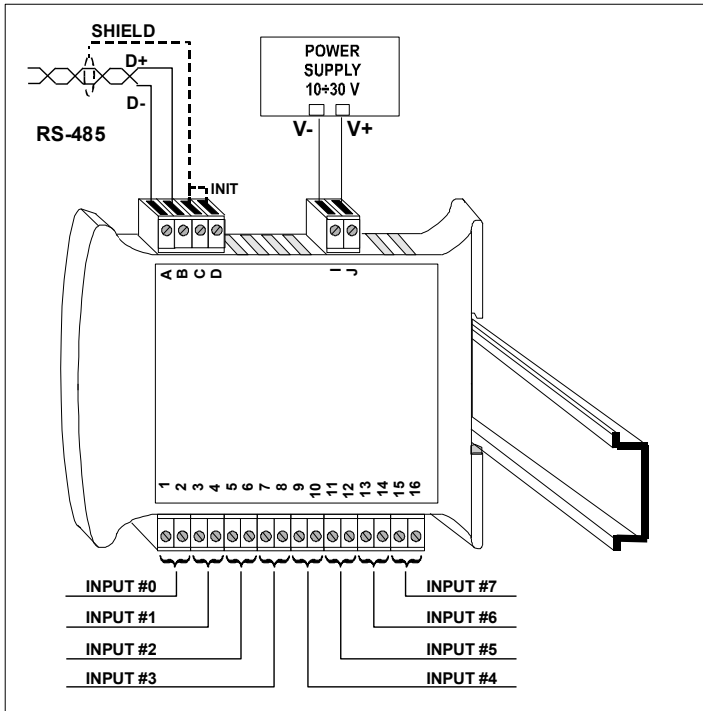

## LIGHT SIGNALLING

LED	COLOUR	STATE	DESCRIPTION
PWR	GREEN	ON	Device powered
		OFF	Device not powered / Wrong RS-485 cabling.
		FAST BLINK	Communication in progress (blink frequency depends to baud-rate)
		1 second BLINK	Watch-Dog Alarm condition

## MECHANICAL DIMENSIONS (mm)

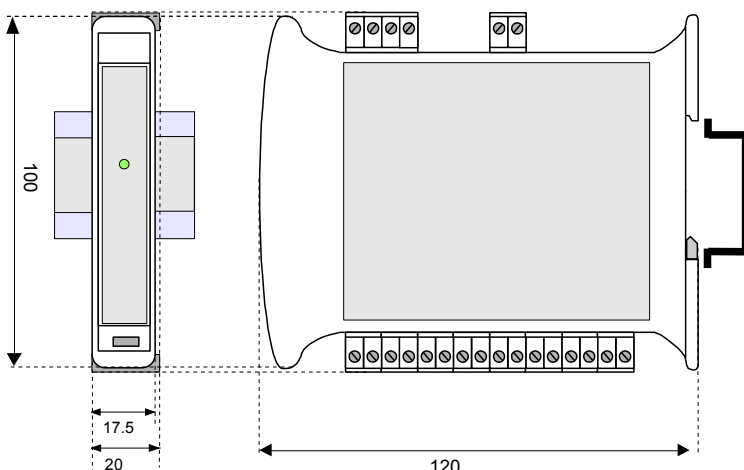

## WIRING

### ANALOG INPUTS

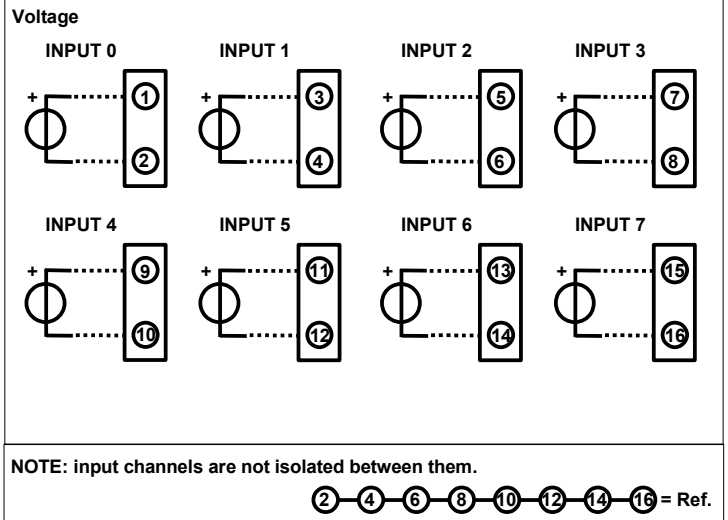

### RS-485 NETWORK

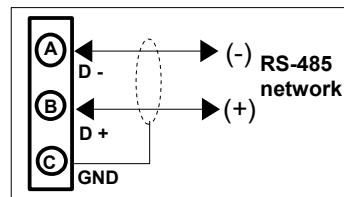

### RS-232 NETWORK

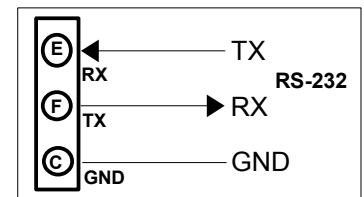

### POWER SUPPLY (\*)

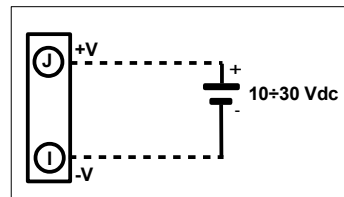

### INIT

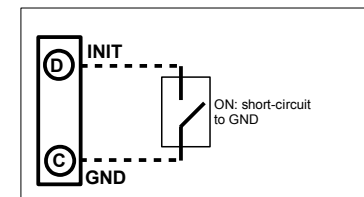

(\*) Note: for UL installation the device must be powered using a power supply unit classified NEC class 2 or SELV

## ISOLATION STRUCTURE

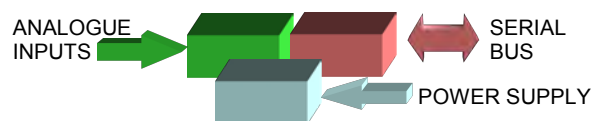

### HOW TO ORDER

In the order phase, it is mandatory to specify the interface type (RS485 or RS232).

### ORDER CODE:

DAT 3017-V / 232

Interface type  
485 : RS-485  
232 : RS-232

■ = Requested  
□ = Optional



The symbol reported on the product indicates that the product itself must not be considered as a domestic waste. It must be brought to the authorized recycle plant for the recycling of electrical and electronic waste. For more information contact the proper office in the user's city, the service for the waste treatment or the supplier from which the product has been purchased.