



USER MANUAL TCT101-1ABC

PIXSYS www.pixsys.net
 e-mail: sales@pixsys.net - support@pixsys.net
 Software V 2.06
 2300.10.120-RevJ 060513



DIMENSION and INSTALLATION

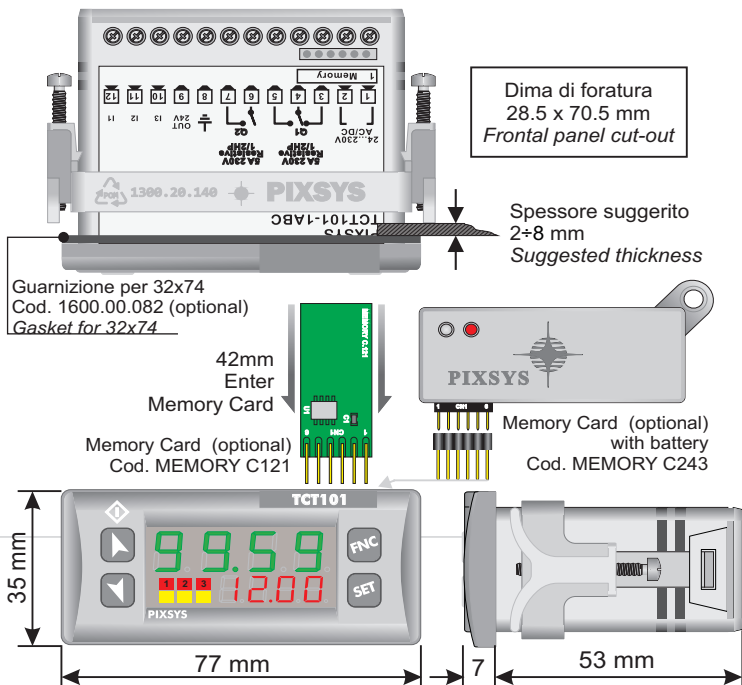

MODIFY SETPOINT		EFFECT
PRESS		
1	SET	Display SETPOINT 1 / 2
2	OR	Modify selected SETPOINT
2a	FNC	Select the chosen digit
3a	OR	Modify the flashing digit of the selected setpoint

LED	MEANING
[Red] [Green] [Yellow]	Report the activation of Q1
[Red] [Green] [Blue]	Report the activation of Q2
[Red] [Green] [Blue] [Yellow]	Report serial transmission by the TCT101

TECHNICAL DATA

Operating temperature Operating temperature 0-40°C, humidity 35..95uR%

Sealing Front panel IP65 (with optional gasket), Box IP30, Terminal blocks IP20

Material PC ABS UL94V0 self-extinguishing

Digital Inputs 3PNP/NPN configurable as analogue for potentiometers. (max 28 Vdc in PNP mode)

Outputs 2 relays 5A resistive charge
OUT 24V 30mA(24Vac), 40mA(24 Vdc), 60mA (110...230Vac)

Back-UP Rechargeable battery, approx. 7days autonomy

Programming Software Labsoftview 2.6 or later

Power Supply 24...230Vac/Vdc +/-15% 50/60Hz / 2W

INTRODUCTION

Thanks for choosing a Pixsys device.

Timer TCT101 can be set in 5 different modes: Timer-ON, Timer-OFF, Pause-Work, Oscillator, PWM (time-proportioned output), all options with independent setting of ON-OFF time. 3 digital inputs are available (NPN/PNP/Potential free contact) for external commands like Start, Stop, Reset; one input is also analogic in order to allow the modification of working times by external potentiometer. 5 different time bases (hundredths, tenths, seconds, minutes, hours).



Read carefully the safety guidelines and programming instructions contained in this manual before using/connecting the device.

Disconnect power supply before proceeding to hardware settings or electrical wirings.

Only qualified personnel should be allowed to use the device and/or service it and in accordance to technical data and environmental conditions listed in this manual.

Do not dispose electric tools together with household waste materials in observance of European Directive 2002/96/CE

WIRING DIAGRAM

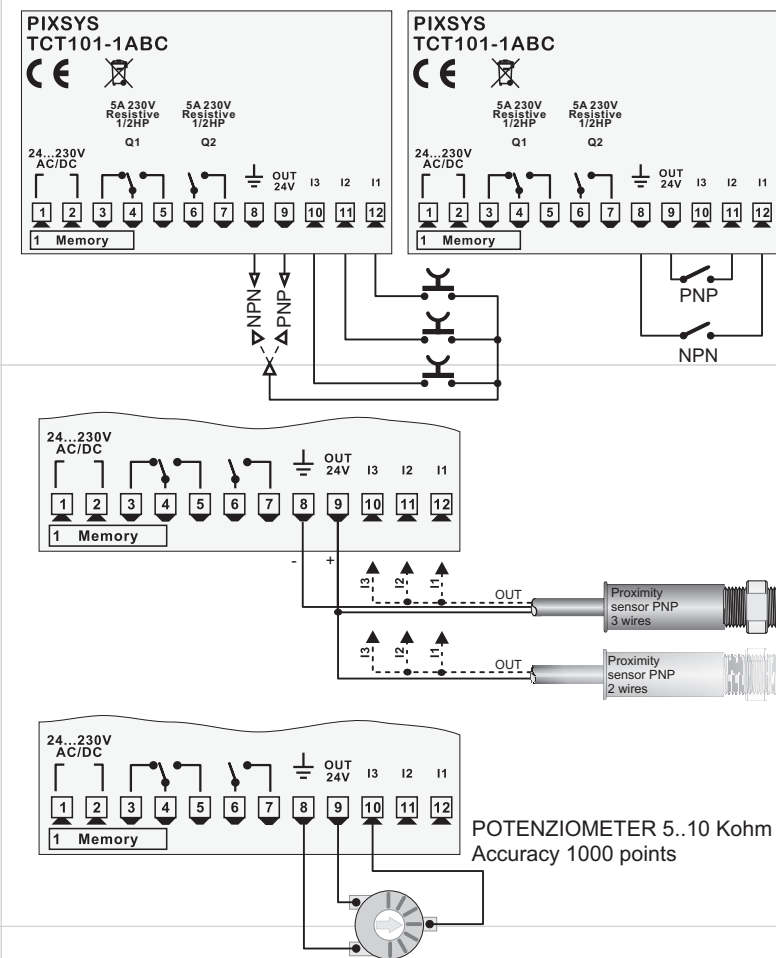

Potentiometer:

To modify Set1 or Set2 by external potentiometer follow the steps below:

- 1- use potentiometers 5kOhm to 10kohm
- 2- connect cursor to pin I3; a wrong connection may damage the potentiometer and lead to lock of the device.
- 3- accuracy on input is max 1000 points, therefore set the parameters "Upper limit" and "Lower limit" with a max difference of 1000 units. (Ex.: LoS1 to 50,0 and uPS1 to 150,0 to modify time value related to Set1 between 50 and 150 seconds with steps of one tenth). Greater differences would make unstable the less significant digit.
- 4- To calibrate the scale of potentiometer enter the configuration mode and select:

Hin.3 as Pot
 Fin.3 as Set1 or Set2
 P.tAr as Enable

Exit configuration mode and place potentiometer at minimum level and press key, then place potentiometer at max level and press premere key: the device automatically exit the calibration procedure.

N.B.: A switch-off of the device would interrupt the calibration.

MEMORY CARD (optional)

Parameters and setpoint values can be copied from one device to another using the Memory car.

There are two methods:

> **With the device connected to the power supply** insert the memory card **when the controller is off.**

On activation display 1 shows and display 2 shows [----]

(Only if the values stored on Mmemory Card are correct).

By pressing the key display 2 shows [---]

Confirm using the key .

The device loads the new data and starts again.

> **With the controller disconnected from the power supply**

The memory card is equipped with an internal battery with uses.

Insert the memory card and press the programming button.

When writing the parameters, the LED turns red and on completing the procedure it changes to green. It is possible to repeat the procedure.

UPDATING MEMORY CARD.

To *update* the memory card values, follow the procedure described in the first method, setting display 2 to [----] so as not to load the parameters on controller.

Enter configuration and **change at least one parameter.** Exit configuration. Changes are saved automatically.

LOADING DEFAULT VALUES

This procedure restores the factory settings of the instrument.

LOADING DEFAULT SETTINGS

PRESS	EFFECT	OPERATION
1	for 3 seconds	Display 1 shows 0000 and 1st digit flashes, Display 2 shows PRSSI
2	Modify the flashing digit, press to reach the next digit	Enter password 9999
3	to confirm	The device loads default values (factory settings) Switch-off and restart the device

MODIFY PARAMETERS

PRESS	EFFECT	OPERATION
1	for 3 seconds	Display 1 shows 0000 and 1st digit flashes, display 2 shows PRSSI
2	Modify flashing digit, press to reach the following digit	Enter password 1234
3	to confirm	Display shows first parameter of configuration table Func
4	Scroll the parameters	
5	Increase or decrease value on display by pressing and one of the arrow keys at same time	Enter new data which will be stored releasing the keys
6	End of configuration, the device exits programming mode.	

LIST of PARAMETERS

FUNCTION CONFIGURATION

Func	P-01 Timer Function	Timer operating modes	
Top	Timer On	Activate output at elapsing of counting	Default
TopFF	Timer Off	Deactivate output at elapsing of counting	
PRUo	Pause/Work	T1 and T2 start in sequence	
osc	Oscillator	T1 and T2 start in sequence and cycling	
PUN	PWM	Activate a percentage of output on a fixed time base	

BACKUP MEMORY CONFIGURATION

PoNE	P-02 Power-off Memory	Memory after switch-off	
d.S	Disable	Disabled	Default
o.T	Only Timer	Memory stores only value of Timer	
ALL	Timer / State	Memory stores value of Timer and START/STOP status	

INPUT CONFIGURATION

H.in1	P-03 Hardware Input 1	Configuration Input 1	
nPn	NPN	NPN	
PnP	PNP	PNP	Default
TTL	TTL	TTL	
H.in2	P-04 Hardware Input 2	Configuration Input 2	
nPn	NPN	NPN	
PnP	PNP	PNP	Default
TTL	TTL	TTL	

H.in3	P-05 Hardware Input 3	Configuration input 3	
PnP	PNP	PNP	Default
TTL	TTL	TTL	
PoT	Potent.	Potentiometer	
F.in1	P-06 Active State Input 1	Activate Input 1	
HLe	High Level	High level	
LLe	Low Level	Low level	
r.S	Rising edge	Rising edge	Default
F.in2	P-07 Active State Input 2	Activate Input 2	
HLe	High Level	High level	
LLe	Low Level	Low level	
r.S	Rising edge	Rising edge	Default
F.in3	P-08 Active State Input 3	Activate Input 3	
HLe	High Level	High level	
LLe	Low Level	Low level	
r.S	Rising edge	Rising edge	Default
F.in1	P-09 Function Input 1	Function of Input 1	
d.S	Disable	Disabled	
SESt	Start / Stop	Start / Stop	Default
SESc	Start / Stop-Reset	Start / Stop-Reset	
r.SSt	Reset-Start / Stop	Reset-Start / Stop	
r.SSc	Reset / Start / Stop	Reset / Start / Stop	
F.in2	P-10 Function Input 2	Function Input 2	
d.S	Disable	Disabled	
r.S	Reset	Reset	Default
F.in3	P-11 Function Input 3	Function Input 3	
d.S	Disable	Disabled	
UA	Wait	Wait (stop the counting)	
HA	Hold	Hold (hold value on display but counting goes on)	Default
SESt	Potent. To SET1	Modify SET1 by potentiometer	
SESc	Potent. To SET2	Modify SET2 by potentiometer	
F.tUp	P-12 Function Key UP	Function of key	
d.S	Disable	Disabled	Default
SESt	Start / Stop	Start / Stop	
SESc	Start / Stop-Reset	Start / Stop-Reset	
r.SSt	Reset-Start / Stop	Reset-Start / Stop	
r.SSc	Reset / Start / Stop	Reset / Start / Stop	
r.S	Reset	Reset	
UA	Wait	Wait (stop the counting)	
HA	Hold	Hold (hold value on display but counting goes on)	

OUTPUT CONFIGURATION

out1	P-13 Output Q1 Setup	Setting of output Q1	
d.S	Disable	Disabled	
t.In	Out Timer 1 n.o.	Output Timer 1 N.O.	Default
t.Inc	Out Timer 1 n.c.	Output Timer 1 N.C.	
t.2n	Out Timer 2 n.o.	Output Timer 2 N.O.	
t.2nc	Out Timer 2 n.c.	Output Timer 2 N.C.	
SESt	Start	Start	
ScSt	Stop	Stop	
out2	P-14 Output Q2 Setup	Setting of output Q2	
d.S	Disable	Disabled	Default
t.In	Out Timer 1 n.o.	Output Timer 1 N.O.	
t.Inc	Out Timer 1 n.c.	Output Timer 1 N.C.	
t.2n	Out Timer 2 n.o.	Output Timer 2 N.O.	
t.2nc	Out Timer 2 n.c.	Output Timer 2 N.C.	
SESt	Start	Start	
ScSt	Stop	Stop	

DISPLAY CONFIGURATION

TYPE	P-15 Type of Timer	Counting mode	
incr	Incremental	Incremental	Default
decr	Decremental	Decremental	

SETPOINT CONFIGURATION

FoS1	P-16 Format Set 1	Format of counting	
SScc	Second.Cent	Seconds, Hundredths	
SSsd	Second.Decimal	Seconds, Tenths	Default
SSs	Second	Seconds	
MSs	Minute.Second	Minutes, Seconds	
HMm	Hour.Minute	Hours, Minutes	
HHh	Hour	Hours	
FoS2	P-17 Format Set 2	Format of counting	
SScc	Second.Cent	Seconds, Hundredths	
SSsd	Second.Decimal	Seconds, Tenths	Default
SSs	Second	Seconds	
MSs	Minute.Second	Minutes, Seconds	
HMm	Hour.Minute	Hours, Minutes	
HHh	Hour	Hours	

d.S1	P-18 Display Set 1	Visualization of Set 1	
d.S2	P-19 Display Set 2	Visualization of Set 2	
d.S	Disable	Disabled	Default
U.Sd	Visualized	Visualized	
Mod	Modifiable	Visualized and modifiable	
LoS1	P-20 Lower limit Set 1	Low limit Set 1	0.0
uPS1	P-21 Upper limit Set 1	Upper limit Set 1	99.9
LoS2	P-22 Lower limit Set 2	Low limit Set 2	0.0
uPS2	P-23 Upper limit Set 2	Upper limit Set 2	99.9
P.tAr	P-24 Potent. tarature	Calibration of potentiometer	
d.S	Disable	Disabled	Default
En	Enable	Enabled	

TCT101-1ABC "TIMER"

FUNCTION CONFIGURATION

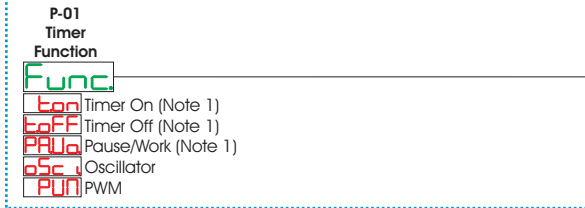

BACKUP MEMORY CONFIGURATION

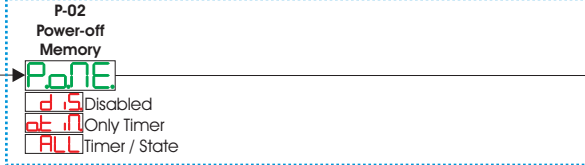

INPUT CONFIGURATION

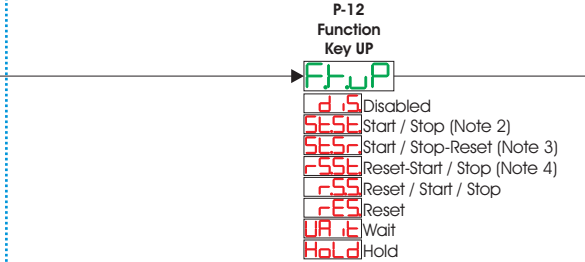
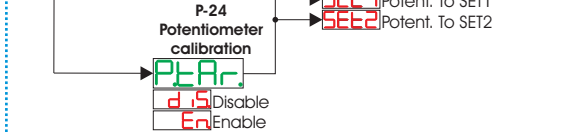
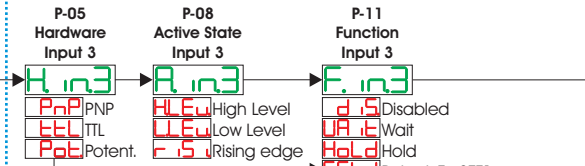
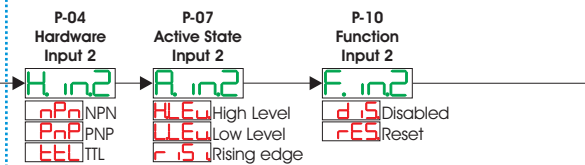
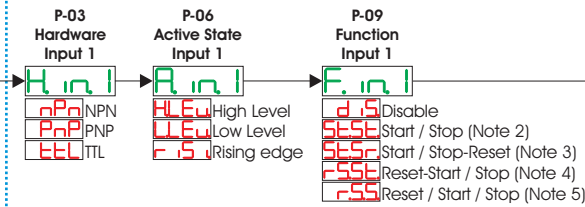

SETPOINT CONFIGURATION

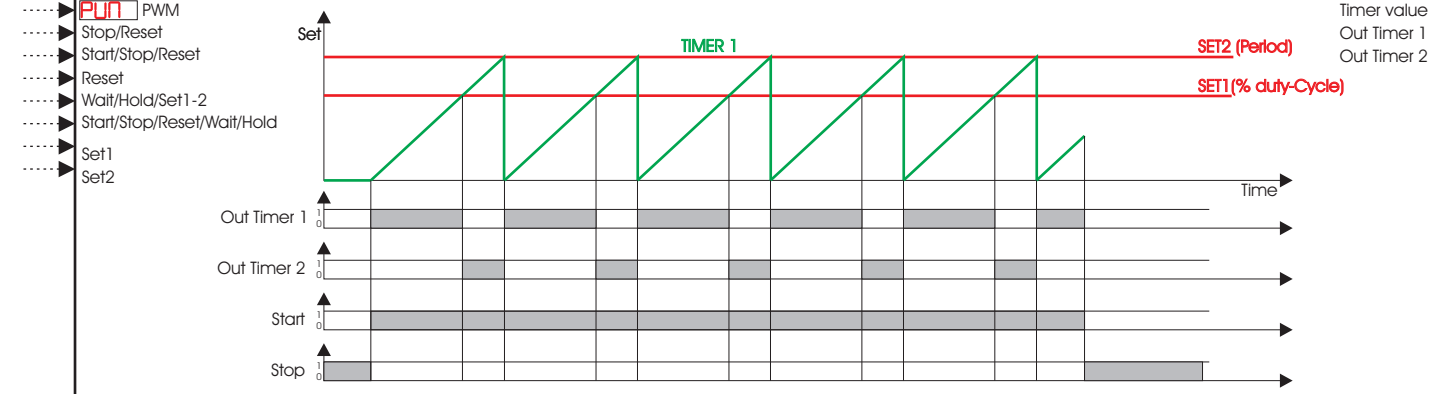
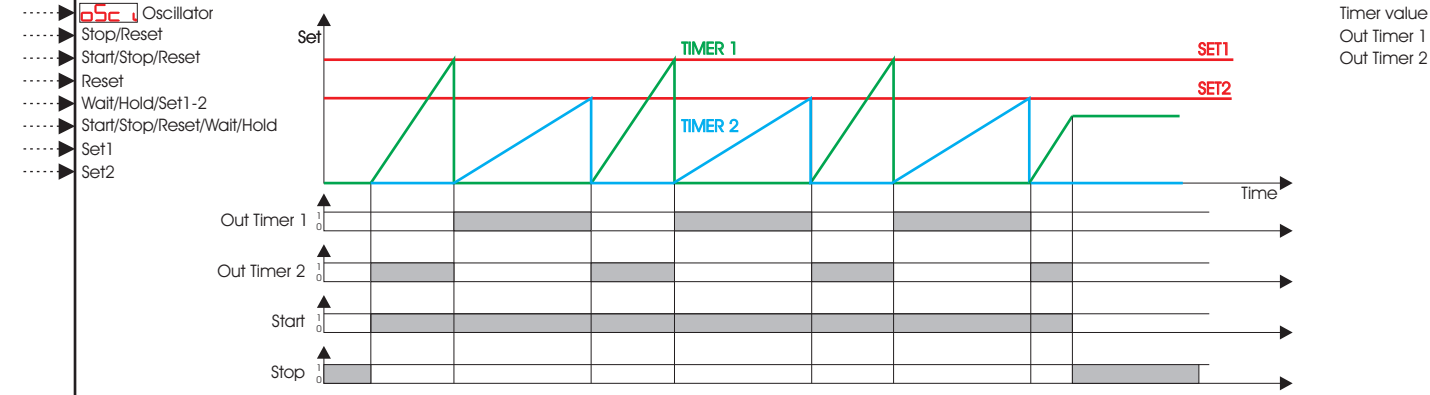
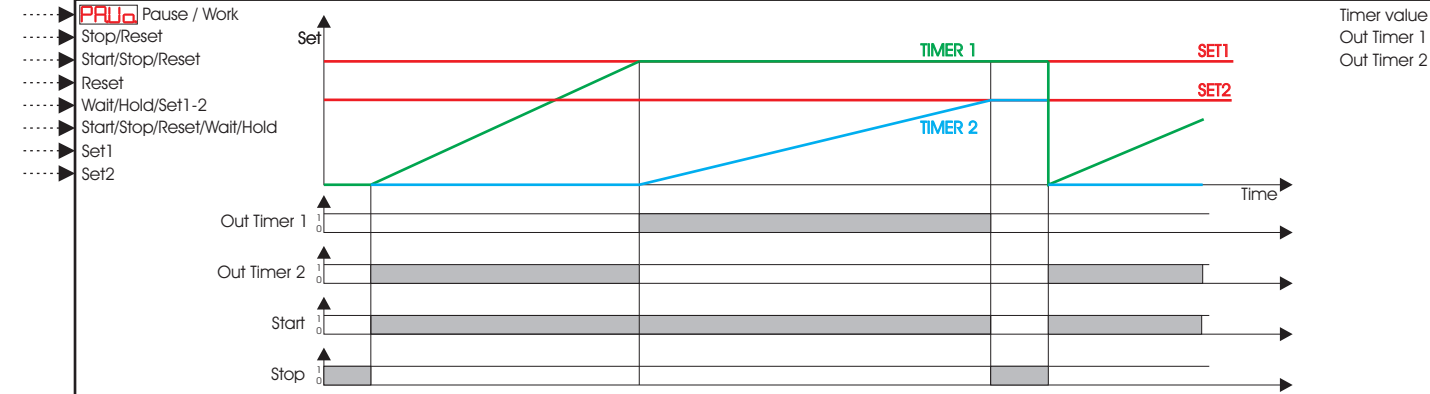
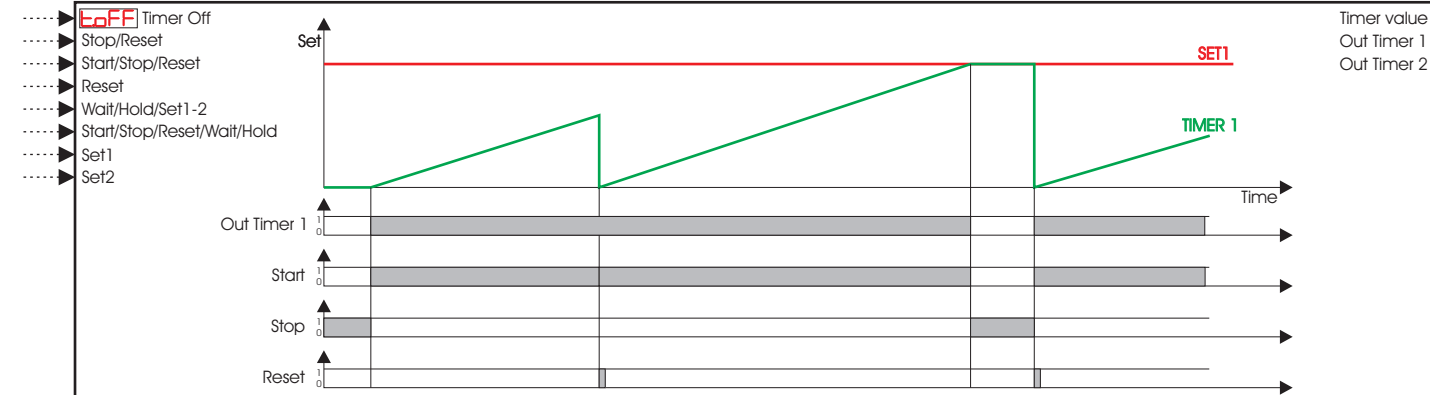
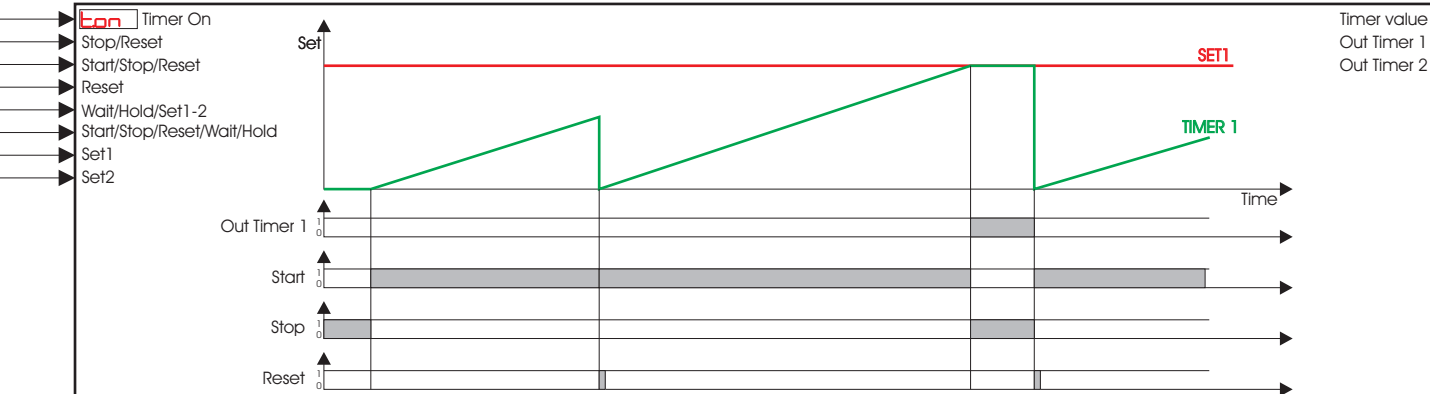
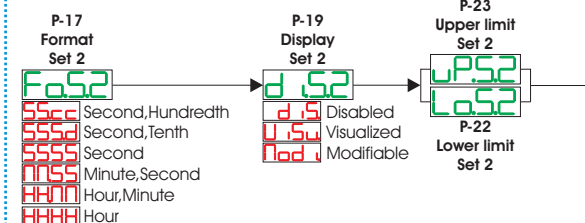
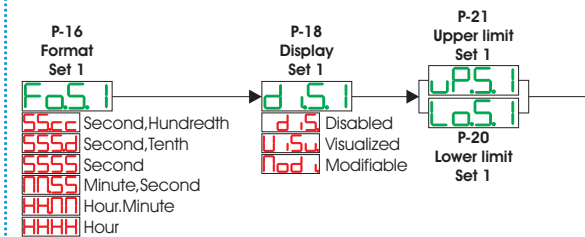

DISPLAY CONFIGURATION

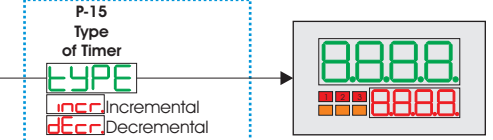

OUTPUT CONFIGURATION

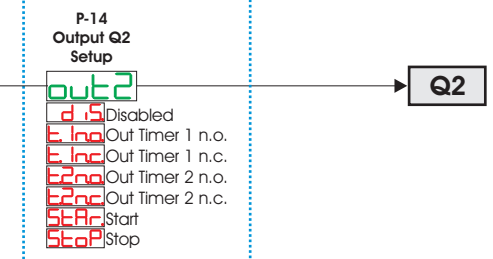
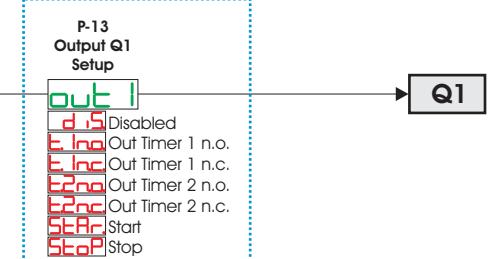

Logic level	Type of input	NPN input	PNP input	TTL input
H		< 4,7 v	> 5,7 v (I1, I2) > 12,4 v (I3)	> 2,5 v
L		> 5,7 v	< 4,7 v (I1, I2) < 10,2 v (I3)	< 2,0 v

TABLE of ERROR MESSAGES

- E-01** ERROR in WRITING of EEPROM Memory (Note 1)
 - E-02** ERROR in READING of EEPROM Memory
 - E-03** Incorrect parameters (Note 1)
 - E-04** Incorrect calibration data (Note 1)
 - E-05** Incorrect status data (Note 1)
 - E-06** Incorrect BACKUP registers! (Note 2)
- Note 1:** Switch the device off and restart it; if error is still notified, contact technical service
- Note 2:** Discharged battery; keep the device connected to power supply in order to recharge the battery.

Note 1: In this timer mode, if P-06 Active State Input 1 = Rising Edge or P-09 Function Input 1 = Disable, at the end of the count (reaching the set), the timer automatically goes to STOP.
Note 2: This function does not reset the timer value, therefore requires an input for reset.
Note 3: This function resets the timer at the instant of the STOP command.
Note 4: This function resets the timer at the instant of the START command.
Note 5: This function is active only if P-06 Active State Input 1 = Rising Edge

⚠ In PWM mode, the only option available on parameters 16 **FS1** and 17 **FS2** for format of SET1 and SET2 is **5555** (seconds). Low and upper limits for SET1 (related to percentage of work or Duty Cycle) are allowed in the range 0 ... 100 (%).